

APPLICATION AND INSTALLATION GUIDE

DIESEL ENGINE CONTROL SYSTEMS

CATERPILLAR®

Contents

| | |
|--|----------|
| Diesel Engine Control Systems | 1 |
| Engine Protection & Monitoring System Parameters | 2 |
| Engine Lubrication System | 2 |
| Lube Oil Pressure | 2 |
| Lube Oil Temperature | 2 |
| Oil Level Alarm | 3 |
| Lubricating Oil Filter Differential Pressure | 3 |
| Crankcase Pressure | 3 |
| Oil Mist Detector Shutdown | 3 |
| Metal Particle Detection | 3 |
| Oil Scavenge Pump Outlet Pressure..... | 3 |
| Engine Cooling System | 4 |
| Jacket Water Temperature | 4 |
| Jacket Water Pressure | 4 |
| Aftercooler Water Temperature..... | 4 |
| Aftercooler Water Pressure | 4 |
| Expansion Tank Level Alarm | 4 |
| Cooling Water Loss-of-Flow Alarm | 4 |
| Sea Water Pressure | 5 |
| Engine Fuel System | 5 |
| Fuel Pressure | 5 |
| Fuel Temperature | 5 |
| Fuel Filter Differential Pressure | 5 |

| | |
|--|----|
| Engine Starting Air System..... | 5 |
| Starting Air Pressure..... | 5 |
| Engine Combustion Air System..... | 5 |
| Inlet Manifold Air Temperature | 5 |
| Inlet Manifold Air Pressure | 5 |
| Air Cleaner Differential Pressure..... | 5 |
| Engine Exhaust System..... | 6 |
| Exhaust Stack Temperature..... | 6 |
| Individual Cylinder Exhaust Temperature..... | 6 |
| Exhaust Temperature Deviation Alarm | 6 |
| Miscellaneous Engine Parameters..... | 6 |
| Engine Speed..... | 6 |
| Clock Hour Meter | 6 |
| Voltmeter | 6 |
| Off-Engine Parameters | 7 |
| Marine Transmission Oil Pressure..... | 7 |
| Marine Transmission Oil Temperature | 7 |
| Generator Stator (Winding) Temperature..... | 7 |
| Generator Bearing Temperature | 7 |
| Recommended Alarms and Shutdowns..... | 7 |
| Engine Control, Protection and Monitoring Systems for Electronic Unit Injection (EUI) Engines | 9 |
| Electronic Control Module (ECM) and Control Software | 9 |
| Electronic Control Module | 9 |
| Electronic Unit Injection (EUI) | 10 |

| | |
|--|----|
| Mechanically Actuated Electronic Unit Injectors (MEUI) | 10 |
| Hydraulically Actuated Electronic Unit Injectors (HEUI) | 10 |
| Engine Instrument Panel..... | 11 |
| ADEM II Control System | 11 |
| ADEM A3 Control System Specifics..... | 11 |
| ADEM A4 Control System Specifics..... | 12 |
| Engine Control, Protection and Monitoring Systems for Mechanical Unit Injection (MUI) Engines | 17 |
| 3600 Series Engines..... | 18 |
| Marine Monitoring System (MMS) | 18 |
| Generator Monitoring System (GMS) | 19 |
| Engine Control Panel (ECP) - Relay Based Protection System | 19 |
| Alarm Panels | 19 |
| 3500 Series & Smaller MUI Engines | 20 |
| Instrumentation Options..... | 20 |
| Protection System Options..... | 20 |
| Electronic Modular Control Panels (EMCP) | 21 |
| EMCP II+ Control Panel..... | 21 |
| EMCP 3.x Control Panel..... | 22 |
| Alarm Modules..... | 22 |
| EMCP II Alarm Modules | 23 |
| EMCP 3 Alarm Annunciator..... | 23 |

| | |
|--|----|
| Other Alarm Modules & Panels | 23 |
| Customer Interface Module (CIM) | 23 |
| Customer Supplied Shutoffs | 24 |
| Engine Communication Methods | 25 |
| Customer Communication Module (CCM) | 25 |
| Programmable Relay Control Module (PRCM) | 25 |
| Relay Driver Module (RDM) | 25 |
| Caterpillar PL1000 Series Communication Modules..... | 26 |
| PL1000T Communication Module | 26 |
| PL1000E Communication Module | 27 |
| Wiring Methods and Considerations | 29 |
| Wire Size and Type | 29 |
| Wire Insulation..... | 29 |
| Support & Protection of Harnesses | 29 |
| Connectors..... | 29 |
| Routing Considerations | 30 |
| Reference Material | 30 |
| Media List | 30 |

Foreword

This section of the Application and Installation Guide generally describes Diesel Engine Control Systems for Caterpillar® engines listed on the cover of this section. Additional engine systems, components and dynamics are addressed in other sections of this Application and Installation Guide.

Engine-specific information and data are available from a variety of sources. Refer to the Introduction section of this guide for additional references.

Systems and components described in this guide may not be available or applicable for every engine.

Information contained in this publication may be considered confidential. Discretion is recommended when distributing. Materials and specifications are subject to change without notice.

CAT, CATERPILLAR, their respective logos, "Caterpillar Yellow" and the POWER EDGE trade dress, as well as corporate and product identity used herein, are trademarks of Caterpillar and may not be used without permission.

Diesel Engine Control Systems

This section on Diesel Engine Control Systems covers multiple inter-related topics dealing with all aspects of diesel engine control, protection and monitoring systems. We begin with a brief discussion of the various diesel engine protection and monitoring system parameters and outlining the purpose of each parameter in order to help determine the appropriate level required for a particular application. This is followed by a discussion of the control system that is currently in use on Caterpillar diesel engines utilizing Electronic Unit Injection (EUI). Finally, we cover the control systems used on Caterpillar diesel engines utilizing Mechanical Unit injection (MUI).

SECTION CONTENTS

| | | | |
|---|-----------|---|-----------|
| Engine Protection & Monitoring System Parameters..... | 2 | Electronic Modular Control Panels (EMCP 3) | 21 |
| <ul style="list-style-type: none"> • Lubrication System • Cooling System • Fuel System • Air Starting • Combustion Air • Miscellaneous • Off-Engine Parameters | | <ul style="list-style-type: none"> • EMCP II • EMCP 3.x • Alarm Modules • Customer Interface Module (CIM) | |
| Engine Control, Protection and Monitoring Systems for Electronic Unit Injection (EUI) Engines..... | 9 | Customer Supplied Shutoffs | 25 |
| <ul style="list-style-type: none"> • ECM and Control Software • Electronic Unit Injection (EUI) • Engine Instrument Panel (EIP) • ADEM™ II • ADEM A3 • ADEM A4 | | Engine Communication Methods..... | 25 |
| Engine Control, Protection and Monitoring Systems for Mechanical Unit Injection (MUI) Engines..... | 17 | <ul style="list-style-type: none"> • Customer Communication Module • Programmable Relay Control Module • Relay Driver Module • PL 1000 Series Communication Modules | |
| <ul style="list-style-type: none"> • 3600 Series Engines • 3500 Series & Smaller MUI Engines | | Wiring Methods & Considerations..... | 29 |
| | | <ul style="list-style-type: none"> • Wire Size & Type • Wire Insulation • Support & Protection of Harnesses • Connectors • Routing Considerations | |
| | | Reference Material | 30 |
| | | <ul style="list-style-type: none"> • Media Numbers | |

Engine Protection & Monitoring System Parameters

Engine protection and monitoring systems supplied by Caterpillar are strongly recommended. Installations not using systems supplied by Caterpillar must obtain factory approval.

A wide variety of preset contactors (switches), transducers and sensors are available to activate a specified alarm, light or engine shutdown. Any equipment operating function can be monitored depending on individual installation requirements. Control system parameters on electronic engines allow the engines to “warn”, “derate” or “shutdown” the engine, when values are not within a specified range. This allows the operator to establish the required engine protection, for parameters such as water temperature and oil pressure, determined by the application. Emergency applications such as emergency generators and fire pumps may warrant disabling this feature.

The following section outlines the various diesel engine systems operating parameters available for protection and monitoring purposes; however, the extent of the instrumentation required will vary with the specific engine model and application. All engines will include the minimum standard protection and monitoring offered by Caterpillar, but the level of protection and monitoring will increase, commensurate with the level of investment.

Minimum engine protection typically includes automatic shutdowns for overspeed, low lubricating oil pressure at both low and high engine speeds and high coolant temperature. Additional shutdowns are available for coolant loss, high lubricating oil temperature, high crankcase pressure and oil mist detection. Refer to the Price List for engine model specific availability.

Engine Lubrication System

Lube Oil Pressure

Oil pressure loss while operating at full power is likely to result in severe engine damage. Reduction of engine speed and load, or stopping the engine can minimize damage. Engine oil pressure must be monitored. Two operating conditions require alarms and shutdowns.

- Low oil pressure at low engine speed (idle conditions)
- Low oil pressure at high engine speed and/or load.

A safe oil pressure while operating at very low loads and/or speeds is too low at full load/speed conditions. The system includes two pressure-sensitive contactors for alarm, two for shutdown and one speed (rpm) switch to decide which pressure switch has the authority to initiate the alarm or shutdown for the engine.

Lube Oil Temperature

Much like all modern diesel engines, Caterpillar engines rely on piston cooling with lubricating oil. Oil

temperature is a good indicator of cooling system operation as well as oil cooler condition. Oil temperature measured near the supply to the engine oil manifolds and piston cooling jets indicates the lube oil cooling system's condition. Higher than normal oil temperatures can result in bearing and/or piston problems.

Oil Level Alarm

Oil pressure and temperature is not the only indicator of lubricating oil system condition. Low oil levels, sometimes caused by an external leak or insufficient oil filling, can cause engine damage. An alarm to signal low oil level in the sump is recommended to reduce the possibility of oil starvation.

Engine tilt, inherent in many marine applications, may cause false low oil level alarms. This can be avoided by measuring the oil level at two locations using two level switches. One switch should be located at the transverse center of the sump at the front or rear, and the other at the longitudinal center on either side. A true low level can be detected when both switches show low level at the same time.

Lubricating Oil Filter Differential Pressure

Lubricating oil filter condition can be accurately monitored with the differential pressure gauge. Differential pressure determines the service period of the lubricating oil filter. Filter service should be signaled with a differential pressure alarm to prevent low lubricating oil pressure delivery to the engine.

Crankcase Pressure

Changing trends in crankcase pressure will normally detect impending problems. Continued operation of an engine with severe problems can result in significant damage to the engine. A gradual increase in crankcase pressure can indicate crankcase breather malfunctions or problems in the piston and piston ring belt areas. A sudden spike indicates piston failure. In these rare instances, the damage occurs much too rapidly to detect by normal gauge observation. Automatic engine shutdown for high crankcase pressure is essential. Crankcase explosion relief valves, standard on some engines and optional on others, can help to minimize the engine damage.

Oil Mist Detector Shutdown

An oil mist detector is required by marine societies on engines with a rating of 2250 kW and higher, or 300 mm bore or larger. An impending main or connecting rod bearing failure can be inferred by measuring oil mist particle size. A smaller particle occurs when bearing temperature exceeds normal limits. Oil mist sensors operate based on this principle. If an oil mist sensor alarm occurs, the engine should be shutdown. It must also be inspected, once it has been allowed to cool.

Metal Particle Detection

Metal particles in the lubricating oil can indicate a serious condition that requires immediate attention.

Oil Scavenge Pump Outlet Pressure

Large engines can be applied in installations requiring very large

external oil sumps in addition to the engine lubricating oil pan (dry sump configuration). In those instances the lubricating oil pressure measured at the scavenge pump outlet can detect lubricating oil system problems prior to low pressure detection in the main engine lubricating oil supply.

Engine Cooling System

Jacket Water Temperature

Jacket water temperature increase is almost as serious as loss of lubricating oil pressure but is more likely to occur. Similar reduction of engine speed and load, or stopping the engine can minimize engine damage. Set the high coolant temperature contactors to activate within 2.8°C (5°F) of the highest normal engine temperature at the time of installation.

Jacket Water Pressure

It is important to maintain jacket water pressure to the engine to prevent overheating. Single engine applications can use an electric emergency jacket water pump to automatically start upon loss of engine driven pump pressure; this is sometimes required by marine classification societies. A low jacket water pressure alarm can warn of impending problems with an engine mounted jacket water pump.

Aftercooler Water Temperature

It is also beneficial to monitor aftercooler water temperature to help determine operating efficiencies of the coolers in the aftercooler circuit. Impending problems with the

inlet regulator can be detected with a gradual rise in water temperature.

Aftercooler Water Pressure

Aftercooler water pressure loss will result in high inlet manifold air temperature and lubricating oil temperature, which can quickly cause engine damage. An electric emergency aftercooler water pump can be installed to automatically start upon loss of engine driven pump pressure; this is sometimes required by marine classification societies. A low aftercooler water pressure alarm can warn of impending problems with an engine mounted aftercooler water pump.

Expansion Tank Level Alarm

While coolant temperatures and pressures are important indicators of cooling system operation, an expansion tank level alarm can indicate low coolant level or loss of system coolant. A low coolant level can activate an alarm or shutdown to prevent engine overheating. In a variable speed application, observance of expansion tank level reduction proportional to engine speed increase is an indicator of air trapped in the coolant system piping.

Cooling Water Loss-of-Flow Alarm

Warning of coolant loss can allow the operator to save an engine which would otherwise be lost to overheat failure. If the high water temperature sensors discussed below are not immersed in water they will not activate. This coolant detection switch is installed on 3600 series engines at the highest location in the jacket water system.

Sea Water Pressure

When using an engine driven seawater pump, it is particularly important to insure that sufficient seawater pressure is delivered to the engine cooler. Engine overheating can result from loss of seawater pressure. Unusually low seawater pump discharge pressure is often used to detect the need to service the seawater pump strainer. In many single engine applications, an electric emergency seawater pump will be used to automatically start upon loss of engine driven pump pressure; this is sometimes required by marine classification societies. A low seawater pressure alarm can warn of impending problems with an engine mounted seawater pump.

Engine Fuel System

Fuel Pressure

Low fuel pressure in the fuel manifold supplying the unit injectors can result in poor performance, reduced power, poor starting characteristics and misfire.

Fuel Temperature

The temperature of the fuel delivered to the engine can be useful for determining the fuel viscosity and power limitations of the engine. Fuel at higher temperatures causes a reduction in maximum available engine power and lower fuel viscosity which can lead to seized injectors. High fuel temperature can present poor performance, power loss and injector durability problems.

Fuel Filter Differential Pressure

Fuel filter condition can be accurately monitored with the

differential pressure gauge.

Differential pressure determines the service period of the filter. Filter service should be signaled with a differential pressure alarm to prevent low fuel pressure delivery to the engine.

Engine Starting Air System

Starting Air Pressure

Low air tank pressure can prevent engine starting until tank pressure is raised to the required level. A low starting air pressure alarm is a time saving feature to alert the operator of impending starting problems prior to attempting to start the engine.

Engine Combustion Air System

Inlet Manifold Air Temperature

High technology diesel engines rely on efficient turbocharger and aftercooler operation to produce the required output within safe operating limits. Air manifold temperature is a good indication of the turbocharger and air inlet system operation. Excessive air manifold temperature indicates problems in the turbo/aftercooler/air intake system.

Inlet Manifold Air Pressure

Air manifold pressure measurement is also helpful in determining the condition of the turbocharger, aftercooler and air inlet system, as well as being an indicator of engine load.

Air Cleaner Differential Pressure

Air cleaner condition can be accurately monitored with the differential pressure gauge. Differential pressure determines the service period of the air cleaner.

Air cleaner service should be signaled with a differential pressure alarm to prevent low inlet manifold air pressure.

Engine Exhaust System

Exhaust Stack Temperature

Changes from normal exhaust stack temperatures give useful information concerning air filter restriction, aftercooler restriction, valve problems, turbocharger fouling and engine speed and load. Excessive temperatures indicate a variety of impending engine problems.

Individual Cylinder Exhaust Temperature

While these instruments will give warning of individual injector failure, the inevitable wide tolerance on the standard temperature, $\pm 42^{\circ}\text{C}$ (75°F), often causes undue operator concern. Advantages gained can be overshadowed by cost, such as the annual replacement of thermocouples, and need for special operator training. These are available on large engines only.

Exhaust Temperature Deviation Alarm

An individual injector failure may be detected with an exhaust port temperature deviation alarm.

Miscellaneous Engine Parameters

Engine Speed

Observing the relationship between engine speed, in rpm, and governor (or rack) can allow the operator to make engine operation and maintenance judgments. Manual

shutdown for an overspeed fault is not possible as an engine will overspeed too quickly for operator reaction. Overspeed faults occur when some part of the engine fails, causing the fuel control mechanism to lock in a high fuel flow condition. When the engine load goes to a low level, the engine will continue to receive a high fuel flow. Without the load, the engine speed increases rapidly to a dangerously high level. Generally, the engine's air and fuel supply must both be cut off to stop the engine. If air operated, the inlet air shutoff requires a minimum air supply pressure for activation force, or 24 VDC for electrically operated air shut-off valves. Overspeed contactors are typically set 13 to 25% nominally over rated engine speed to avoid nuisance engine shutdowns during sudden reductions in engine load.

Clock Hour Meter

Operating hours are essential for determining required maintenance intervals.

Voltmeter

Voltage of the starter/alternator circuit gives useful information regarding battery condition, alternator condition, state of charge of the batteries and condition of battery cables. A voltmeter is highly recommended on electronically controlled engines because voltage drops below 9/18 volts will cause the engine to shutdown.

Off-Engine Parameters

Marine Transmission Oil Pressure

Transmission oil pressure measurement shows when the transmission clutches have engaged and provides useful information concerning the condition of the pump, filters, or clutches. Excessive pressure can damage components in the hydraulic circuit. Low oil pressure will allow the clutches to slip, causing damage to the clutch discs.

Marine Transmission Oil Temperature

Many transmission problems, such as clutch slippage, insufficient clutch pressure, bearing wear, cooler blockage, or loss of cooling water flow will be manifested as an increase in transmission oil temperature.

Generator Stator (Winding) Temperature

Many generators include 100 Ohm platinum Resistive Temperature

Devices (RTD's) or type J Iron-Constantan thermocouples for monitoring winding temperature. Insufficient generator air flow, excessive current output and high ambient temperature cause high winding temperature.

Generator Bearing Temperature

Many large generators include 100 Ohm platinum RTD's for monitoring bearing condition.

Recommended Alarms and Shutdowns

The engine protection and monitoring system parameters discussed above are the standard systems. Customers routinely add alarms and shutdowns to meet the needs of the application. **Table 1** suggests various alarms and shutdowns to be considered and how they might be applied. This chart is frequently modified to fit the site, application and maintenance personnel preferences.

| Diesel Engine Controls and Safety Devices | | |
|--|-------------------|-----------------|
| Malfunction | Unattended | Attended |
| Low Oil Pressure | S | S |
| High Oil Temperature | A | A |
| Low Oil Level | A | A |
| High Oil Filter Differential Pressure | A | A |
| Crankcase Pressure | S | S |
| Oil Mist Detection | A | A |
| Metal Particle Detection | A | A |
| High Jacket Water Temperature | S | S |
| Low Jacket Water Pressure | A | A |
| High Aftercooler Water Temperature | A | A |
| Low Aftercooler Water Pressure | A | A |
| Low Water Level | A | A |
| Cooling Water Loss-of-Flow (3600 Only) | S | S |
| Low Sea Water Pressure | A | A |
| Low Fuel Pressure | A | A |
| High Fuel Temperature | A | A |
| High Fuel Filter Differential Pressure | A | A |
| Low Starting Air Pressure | A | A |
| High Intake Manifold Air Temperature | A | A |
| High Exhaust Stack Temperature | A | A |
| High Exhaust Temperature Deviation | A | A |
| Engine Overspeed | S | S |
| S – Engine Shutdown A – Alarm only | | |

Table 1

Engine Control, Protection and Monitoring Systems for Electronic Unit Injection (EUI) Engines

The Caterpillar ADEM™ system is specifically designed to control and interface with Electronic Unit Injector (EUI) equipped diesel engines. The ADEM electronic controls integrate start/stop controls, speed governing, engine sensing/monitoring and fuel injection control into one comprehensive engine control system for optimum performance and reliability.

There are three versions of this control system in use on current Caterpillar engines.

- ADEM II
- ADEM A3
- ADEM A4

Refer to **Table 2** and the Price List for a specific engine's control system.

The basic ADEM control system is generally the same for all three systems. Common system features will be outlined first and descriptions of the individual control system versions will follow.

Electronic Control Module (ECM) and Control Software

- Electronic Unit Injectors (EUI):
 - Mechanically actuated and Electronically controlled Unit Injectors (MEUI)
 - or
 - Hydraulically actuated and Electronically

controlled Unit Injectors (HEUI)

- Injection Actuation Pressure Control Valve (IAPCV) on HEUI engines only
- Wiring Harness
- Engine switches and sensors

Electronic Control Module

The Electronic Control Module (ECM) controls most of the functions of the engine. The module is an environmentally sealed unit installed in an engine-mounted junction box. The ECM monitors various inputs from sensors in order to activate relays, solenoids and other devices at the appropriate levels. The ECM supports the following primary functions:

- Start/stop control
- Engine speed governing
- Engine monitoring and protection

The ECM control parameters are all preset at the factory with any site specific reprogramming performed by Caterpillar service personnel during the commissioning process. The Caterpillar Electronic Service Technician (Cat ET) service tool is used for any needed reprogramming.

The ECM control parameters include start/stop control, engine speed governing and engine monitoring and protection.

Start/Stop Control

The ECM contains the logic and outputs for control of engine starting and shutdown, including prelubrication and postlubrication, when available. The customer programmable logic responds to signals from the engine control switch, emergency stop switch, remote start switch, data link and other inputs, and the ECM controls the prelube pump (when available), the starting motor, and the electronic fuel injector solenoid valves at the appropriate times.

Engine Speed Governing

The ECM governs the engine speed by controlling the amount of fuel that is delivered by the injectors.

The ECM compares the desired engine speed to the actual engine speed and adjusts the amount of fuel injected until the actual engine speed matches the desired engine speed. Desired speed is based on throttle switch position and actual speed is based on engine speed/timing sensor signals.

Engine Monitoring and Protection

The ECM monitors engine operation and the electronic system. Any problems with the engine operation will cause the ECM to generate an event code that can issue a warning or cause a shutdown. The severity of the condition determines whether a warning is issued or the engine is shutdown. Problems with the electronic system produce a diagnostic code that can be addressed using the Cat ET.

Electronic Unit Injection (EUI)

The ECM controls the timing, duration and pressure of the fuel by varying the signals to the injectors. The timing and duration of the injection is controlled through the injector solenoid valves, common to all electronic unit injectors. The fuel pressure is controlled by two different means of injector actuation, either mechanical or hydraulic.

Mechanically Actuated Electronic Unit Injectors (MEUI)

Mechanically Actuated Electronic Unit Injectors (MEUI) use the engine camshaft and push rods to generate fuel injection pressure, while the ECM controls the amount of fuel injected.

Hydraulically Actuated Electronic Unit Injectors (HEUI)

Hydraulically Actuated Electronic Unit Injectors (HEUI) use a hydraulic pump and engine oil to generate fuel injection pressure. On the HEUI system, the ECM modulates the injection pressure by varying the signal to the Injection Actuation Pressure Control Valve (IAPCV). The IAPCV controls the pressure of the high-pressure oil which pressurizes the fuel that is in the injectors.

Engine Instrument Panel

The Engine Instrument Panel (EIP) is part of the standard scope of supply for some engines and optional for others. Refer to the Price List for a specific engine's scope of supply.

For Caterpillar packaged generator sets, Electronic Modular Control Panels (EMCP II or EMCP 3.X) are used to consolidate engine and generator control, monitoring and protection functions. These panels are discussed in more detail in the service literature for each engine.

ADEM II Control System

The following is a list of features and details specific to the ADEM II control system. Refer to **Figure 1** for a typical ADEM II control system schematic.

Although fuel cooling is standard for the ADEM II, air-cooling is an option. Note that the ECM has a maximum operating temperature of 85°C (185°F)

Features for the ADEM II include:

- 2 x 40-Pin Input/Output Connectors
- Fuel cooling of the ECM is required in some cases
- Actuators for starter motor control, integrated prelube control and air shut-off control are optional
- Communication
 - Cat Data Link
 - CAN 2.0 Data Link/24V ATA Data Link

- RS-232 Data Link
- Sensor Power Supplies
 - Analog Sensor Supply (5V)
 - Digital Sensor Supply (8V)
 - Speed/Timing Sensor Supply (12V)

ADEM A3 Control System Specifics

The following is a list of features and details specific to the ADEM A3 control system. Refer to **Figure 2** for a typical ADEM A3 control system schematic.

- 2 x 70-Pin Input/Output Connectors
- The ECM is fuel cooled to maintain operational temperatures.
- Communication
 - J1939 (CAN) Data Link
 - ATA (J1587) Data Link
 - High Speed Proprietary Data Link
- Sensor Power Supplies
 - Analog Sensor Supply (5V, 400mA)
 - Digital Sensor Supply (8V, 400mA)
 - Speed Sensor Supply (13V, 60mA)

ADEM A4 Control System Specifics

The following is a list of features and details specific to the ADEM A4 control system. Refer to **Figure 3** for a typical ADEM A3 control system schematic.

- 1 x 70-Pin Input Connector and 1 x 120-Pin Output Connector
 - The ECM is fuel cooled to maintain operational temperatures; however, customers can select an optional air-cooled arrangement if adequate airflow and maximum ambient temperature requirements can be documented. The ECM has a maximum operating temperature of 85°C (185°F).
- System does not support EMS, it is replaced with Caterpillar Messenger
 - System interfaces with some electronic transmissions
 - Communication
 - J1939 (CAN) Data Link
 - Sensor Power Supplies
 - Sensor Supply (5V, 450mAdc)
 - Sensor Supply (5V, 80mAdc OEM)
 - Sensor Supply (8V, 150mAdc)
 - Speed/Timing Sensor Supply (13V, 30mAdc)

Typical ADEM II Control System

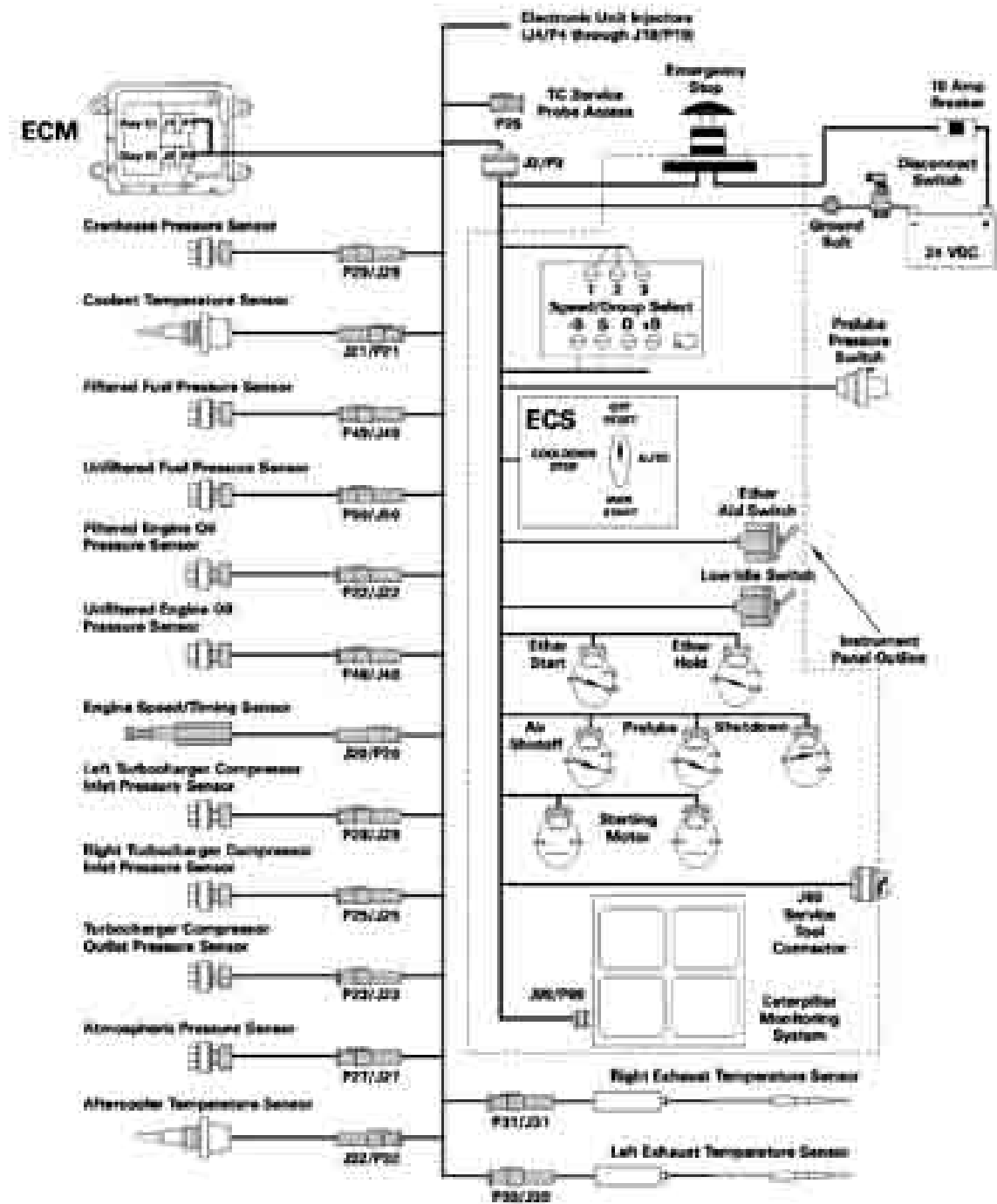

Figure 1

Typical ADEM A3 Control System

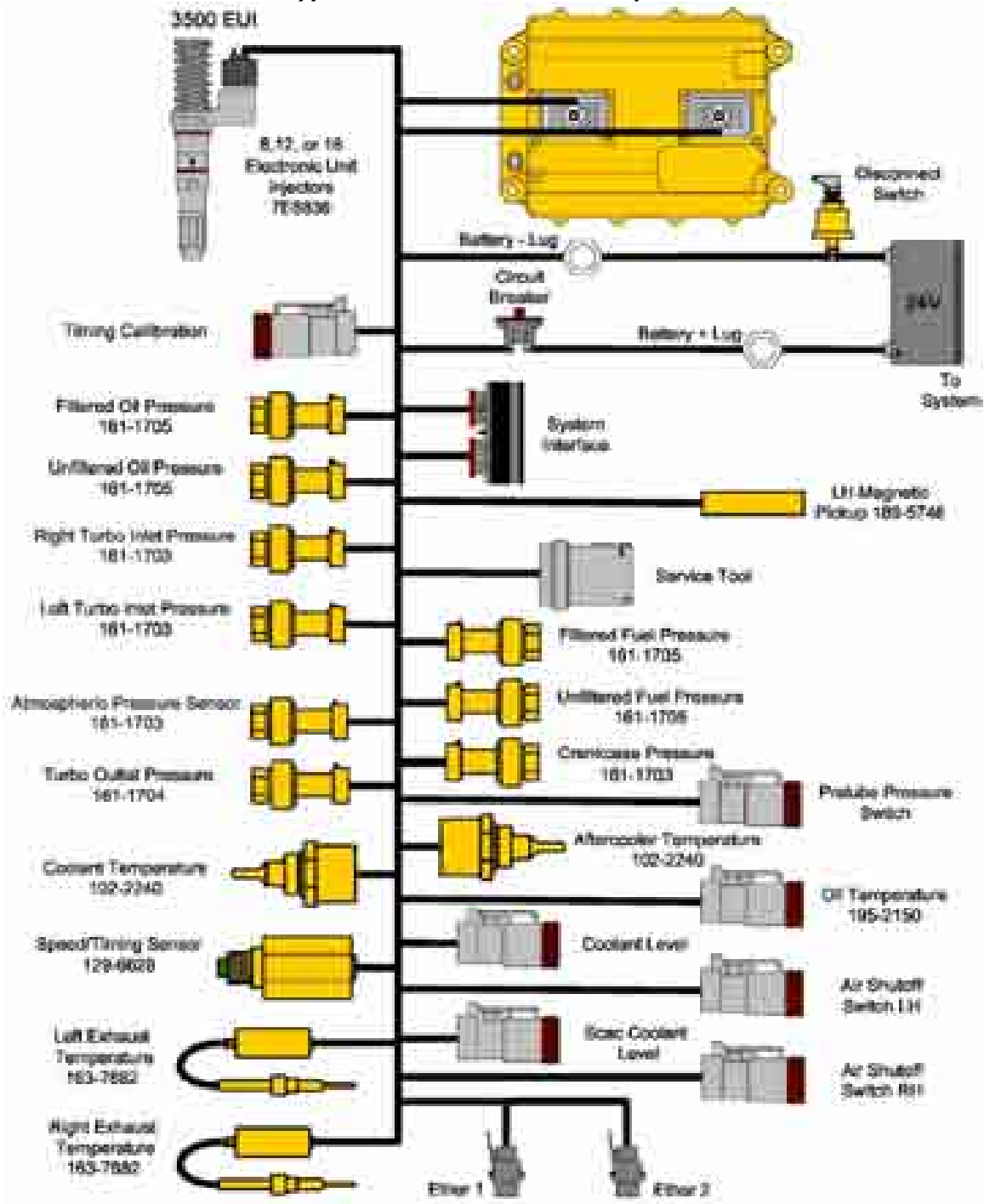

Figure 2

Typical ADEM A4 Control System

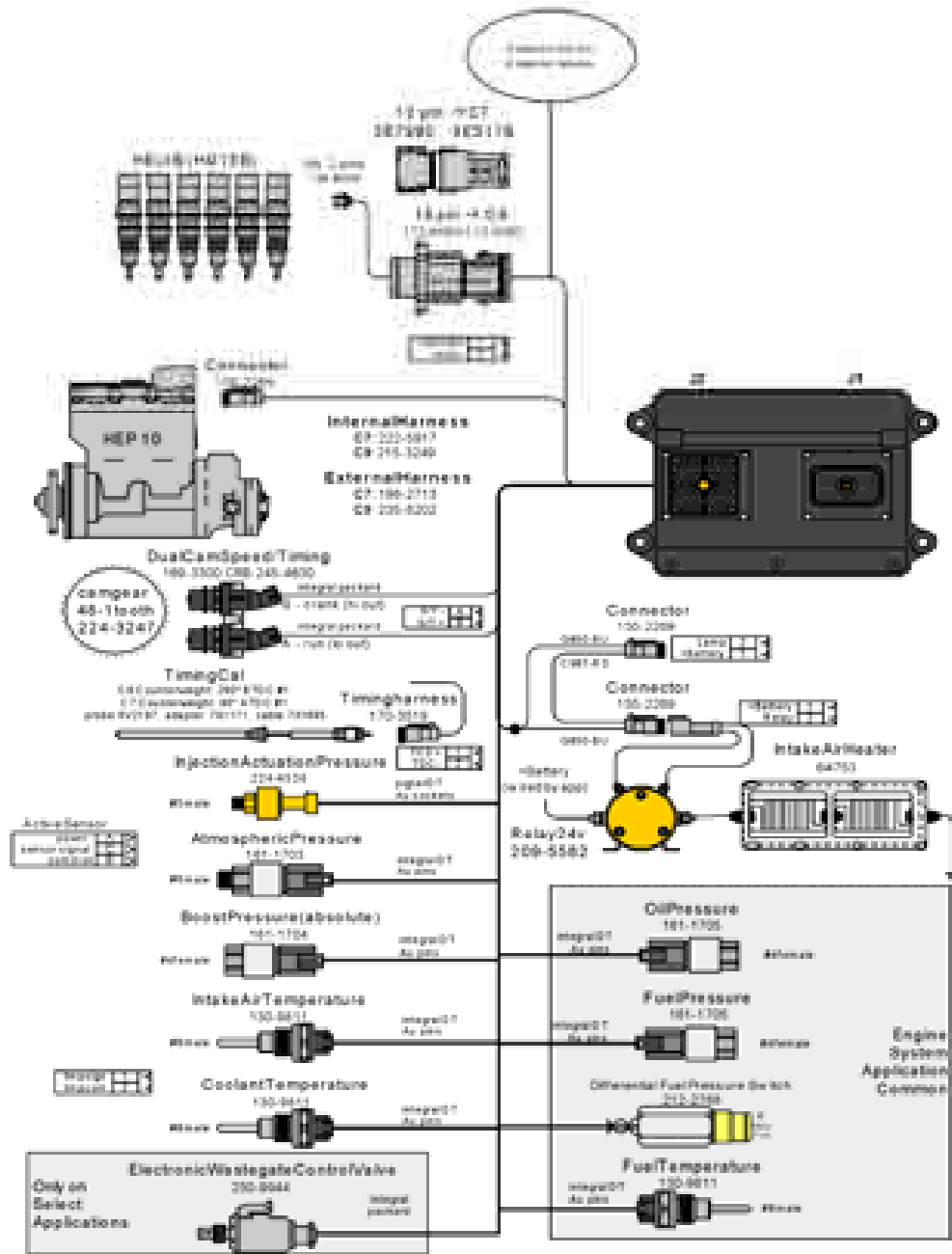

Figure 3

| Caterpillar ADEM System Matrix | | | |
|---------------------------------------|----------------|-----------------------|-------------------|
| Engine Model | ADEM II | ADEM A3 | ADEM A4 |
| 3126B | | X | |
| 3400E | X | | |
| 3500B | X | X | |
| 3500C | | X | |
| C7 | | Models without ACERT™ | Models with ACERT |
| C9 | | Models without ACERT | Models with ACERT |
| C10 | | Models without ACERT | Models with ACERT |
| C12 | | Models without ACERT | Models with ACERT |
| C13 | | Models without ACERT | Models with ACERT |
| C15 | | Models without ACERT | Models with ACERT |
| C16 | | Models without ACERT | Models with ACERT |
| C18 | | Models without ACERT | Models with ACERT |
| C27 | | Models without ACERT | Models with ACERT |
| C30 | | Models without ACERT | Models with ACERT |
| C32 | | Models without ACERT | Models with ACERT |
| C175 | | | X |

Table 2

Engine Control, Protection and Monitoring Systems for Mechanical Unit Injection (MUI) Engines

Control, protection and monitoring systems are a basic requirement of all engine installations, and provide protection to the engine as well as to the facility and operating personnel. All Caterpillar MUI engines are controlled using separate engine speed governing systems. These systems are discussed in the *Governors – Gas & Diesel Application & Installation Guide*. This section provides basic information about the Caterpillar MUI Engine protection and monitoring systems.

While engine protection and monitoring are appropriate and useful for diesel engine systems in general, they are essential for the lubrication and cooling systems. The lubrication system must maintain the oil pressure within a certain range; oil temperature is internally controlled via a coolant thermostat for most arrangements. The cooling system must maintain the cooling water below a certain temperature. Overspeed protection is also very important. These three parameters form the basis for the standard protection system common to all diesel engines.

- Low Oil Pressure
- High Water Temperature
- Overspeed

A listing of standard and optional instrumentation and protection systems can be found with each engine pricing arrangement in the price list. The details of these

offerings will be expanded upon in the following sections.

When designing an installation, consider if the engines will be attended or unattended when selecting protection and monitoring equipment. When attended, alarms can be provided to warn of approaching shutdown limits in each monitored system before an actual engine shutdown occurs. This allows the attendant to decide the urgency of the fault and schedule repairs before a shutdown. Protection equipment for unattended applications can be tailored to the specific requirements.

Although most Caterpillar diesel engines are equipped with a standard set of shutoffs, some engines are configured with additional shutoffs and alarms. They may also use different strategies for shutdowns, annunciation and other features. Refer to the diesel engine schematics for each engine to connect to a specific engine's safety system.

Diesel generator set engines are offered with Energize-To-Run (ETR) and Energize-To-Shutoff (ETS) fuel shut-off systems, which are discussed in more detail in the *Governors – Gas & Diesel Application & Installation Guide*.

3600 Series Engines

Caterpillar offers three types of engine protection and monitoring systems for the 3600 engine family. They are the Marine Monitoring System (MMS), the Generator Monitoring System (GMS) and the Engine Control Panel (ECP) - Relay Based Monitoring System.

Marine Monitoring System (MMS)

The Caterpillar MMS is a microprocessor based engine control, protection and monitoring system designed specifically for marine applications. MMS is also available for petroleum and industrial applications that do not involve generators.

The control features of the system enable the operator to start and stop the engine locally from the MMS panel or remotely. The minimum protection features enable the system to shut down the engine if overspeed, low oil pressure, high water temperature, high crankcase pressure or oil mist detector parameters exceed the set points

The monitoring features allow the operator to view current operating conditions of various engine parameters. A ten inch color display touch screen provides the information and shows when a parameter is in alarm condition.

The MMS utilizes all engine-mounted sensors, so there are no customer pressure connections or temperature capillary connections. All sensors are wired to an engine mounted terminal box, and the entire system is enclosed in a single panel for ease of installation. The MMS can also communicate with other shipboard alarm systems via an industry standard data link connection. The system has been designed to meet most marine classification society's requirements for unmanned engine room operation. The MMS is flexible and allows customers to add additional monitoring and alarm parameters. These can include bilge level alarms, marine reduction gear oil temperature and pressure and others. See **Figure 4** for a typical MMS system diagram.

Marine Propulsion Engine Control and Monitoring System Block Diagram

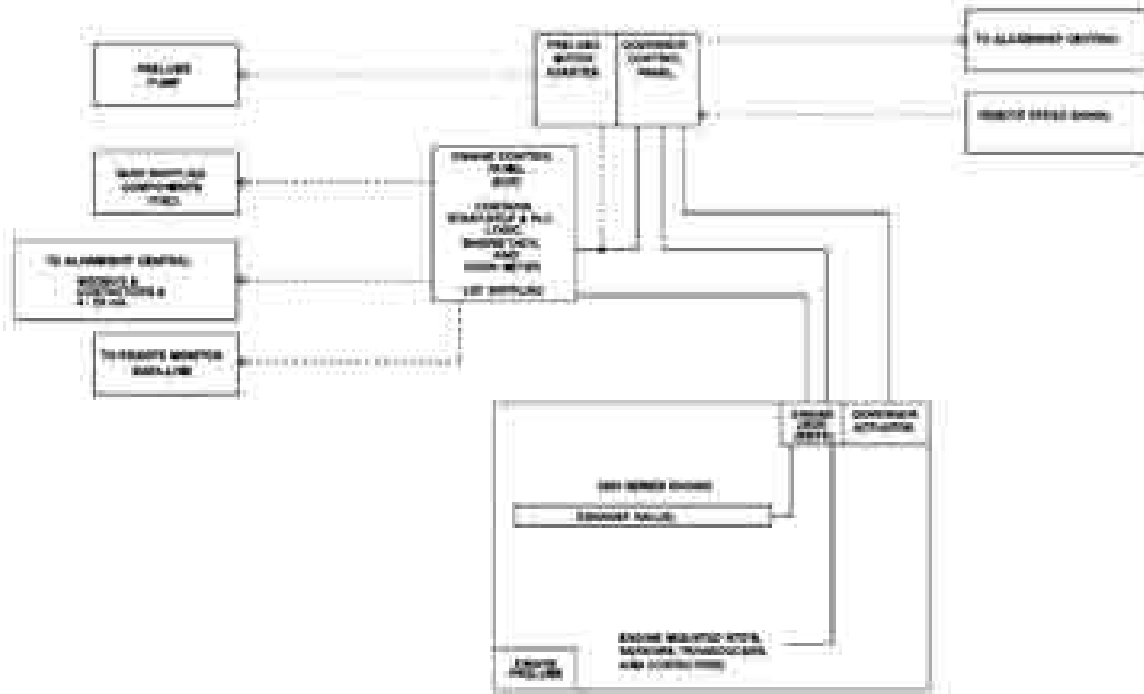

Figure 4

Generator Monitoring System (GMS)

The Caterpillar GMS, used in power generation applications, is identical to the MMS, but with six additional sensor inputs for generator bearing and stator temperatures. The optional PM3000 module allows basic electrical parameters to be included on the color display.

Engine Control Panel (ECP) - Relay Based Protection System

Caterpillar also offers an ECP relay based protection system that uses separate panels for control, protection and monitoring. A start/stop control panel provides these functions for the engine. A customer-mounted junction box contains the relay protection logic

and separate contactor panel provides the required switches for alarm and shutdown parameters. Flexible hoses must be used to connect the pressure switches from the contactor panel to the engine; temperature switch capillaries must also be connected to the engine. A separate relay based alarm annunciation panel is also available with this system.

Alarm Panels

If the optional alarm annunciation panel is not used, Caterpillar recommends the following minimum alarm panel features.

- Fault light lock-in circuitry keeps the fault light on when intermittent faults occur.

- Lockout of additional alarm lights prevents subsequent alarm lights from going on after the activated engine shut-off stops the engine. This aids in troubleshooting.
- Alarm silence allows the operator to acknowledge the alarm without the need to continually listen to the alarm horn. The alarm light is left on until the fault is corrected.
- If more than one engine is connected to an alarm panel, a fault in a second engine should activate the alarm even though the alarm horn may have been silenced after a fault on another engine.
- Circuit test provides for periodic checking of alarm panel functions.

3500 Series & Smaller MUI Engines

Caterpillar 3500 series and smaller diesel engines offer several instrumentation and protection system options. In the price list, the desired instrumentation and protection systems are selected from lists of available options. Not all options are available for every engine; consult the use codes for compatibility.

Instrumentation Options

An engine-mounted instrument panel is standard on most 3500 series and smaller MUI engines. For many applications, this panel may provide a sufficient level of instrumentation, but some applications will require a higher

level; these instrumentation options are included in each model specific price list.

Each model specific price list includes other instrumentation options that may be available for that model, including mechanical and digital tachometers, pyrometers, thermocouples, marine pilot house and reduction gear panels.

Protection System Options

The standard engine protection system provided on MUI engines typically includes Energized to Shutdown (ETS) fuel shutoff protection for low oil pressure, high water temperature and overspeed. However, there are numerous protection system options available for MUI engines. Refer to the price list for model specific protection system option availability.

Electronic Modular Control Panels (EMCP)

An all-inclusive protection and monitoring system, available on generator sets, is the Electronic Modular Control Panel (EMCP). This Caterpillar family of control panels, including EMCP II and EMCP 3, provides basic to complete generator set monitoring. The EMCP's also contain generator set controls (GSC) and several instrument panel switches plus optional alarm modules and customer interface module.

The GSC provides the following.

- Controls starting and stopping of the engine
- Displays engine condition and generator output
- Displays engine faults and codes
- Displays GSC programming information

The safeties and shutdowns are all contained in the EMCP. Set points are programmed into the EMCP using a keypad on the GSC.

Safeties and shutdowns are contained in the EMCP. Their set points are programmable.

EMCP II+ Control Panel

The Caterpillar Electronic Modular Control Panel (EMCP II+) provides full-featured power metering, protective relays, simultaneous display of engine and generator parameters, and expanded AC metering.

Engine and generator controls, diagnostics and operating information is available via the control panel, shown in **Figure 5**, or a remote personal computer. Safety and shutdown set points are programmed using a keypad on the GSC.

Additional modules add to the flexibility of the EMCP II+. These include:

- Alarm modules NFPA 99/110
- Customer Interface Module
- Manual Synchronizing Module
- Customer Communication / PL1000x module
- Relay Driver Module

These modules, discussed later in this section, provide operation and maintenance flexibility to the application.

EMCP II+ requires isolation from engine vibration. Maximum vibration of the panel is 2.0 g's @ 18 to 500 Hz. Input power requirement of 10 watts (24 VDC) on generator standby with no alarms.

EMCP II + Instrument Panel

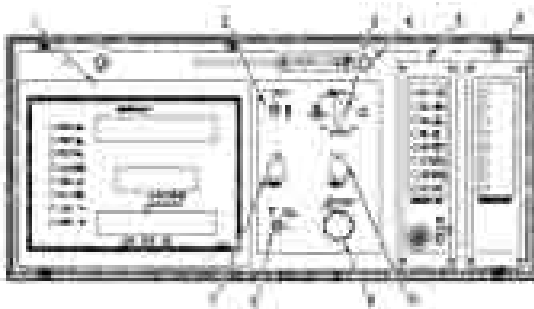

Figure 5

1. Generator Set Control+ (GSC+)
2. Engine Control Switch (ECS)
3. Start Aid Switch (SAS)
4. Panel Lights (PL)
5. Alarm Module (ALM) (Optional)
6. Synchronizing Lights Module (Optional) or Custom Alarm Module (CAM) (Optional)
7. Speed Potentiometer (SP) (Optional) or Governor Switch (Optional)
8. Voltage Adjust Rheostat (VAR)
9. Emergency Stop Push Button (ESPB)
10. Panel Light Switch (PLS)

EMCP 3.x Control Panel

The EMCP 3.x is a new generation of control panels that provides Modbus and J1939 communication protocols. An example of the instrument panel is shown in **Figure 6**.

Similar to the EMCPII+, the EMCP 3.x allows for relay control (dry contacts), automatic starts, cool-down timers and complete annunciation of generator parameters. In addition, the 32-bit processor of the EMCP 3.x allows for 5 levels of password protection and eliminates the need for many of the gauges, meters, and switches required in the past.

The safety and shutdown setpoints can be programmed using the onboard keypad and display or via the Caterpillar Service Tool.

Complete application and installation requirements for the EMCP 3.x can be found in the EMCP 3 Application & Installation Guide, Media Number LEBE5255.

EMCP 3 Instrument Panel

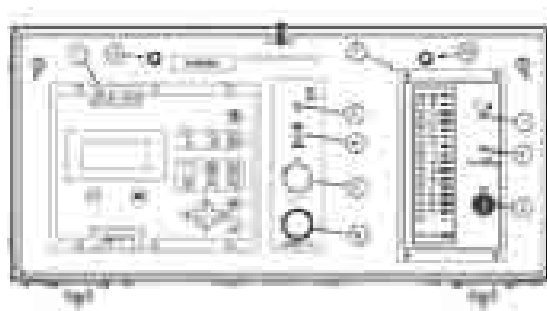

Figure 6

1. Electronic Control Module (ECM) for the Generator Set
2. Annunciator Module (ALM)
3. Panel Light Switch (PLS)
4. Ether Start Aid Switch (SAS) (optional)
5. Speed Potentiometer (SP) (optional)
6. Emergency Stop Push Button (ESPB)
7. Lamp Test Switch
8. Alarm Acknowledge/Silence Switch
9. Alarm Horn
10. Panel Lights

Alarm Modules

Alarm modules, both local and remote, are optional equipment, available as an attachment to the EMCP. These provide red and amber LED's plus an audible indicator.

EMCP II Alarm Modules

Two standard versions of the alarm module are available for use with EMCP II.

- NFPA 99 alarm module
- NFPA 110 alarm module

The NFPA 99 provides alarms for low oil pressure, low coolant temperature and high coolant temperature. The NFPA 110 provides alarms for low oil pressure, low coolant temperature and high coolant temperature, low battery voltage, battery charge malfunction and system not in auto.

Alarm modules used with EMCP II connect to the GSC via a serial data link and must be located within 305 m (1000 feet).

EMCP 3 Alarm Annunciator

The optional EMCP 3 Alarm Annunciator is configurable to the standards of NFPA 99/110 for local and remote annunciation. It can annunciate alarm conditions received from any module on the J1939 data link, including the EMCP 3, engine ECM, RTD module, DIO module, and Thermocouple module. The Annunciator can be mounted locally, on the package generator set, or remotely (up to 800 feet) on the Accessory J1939 Data Link.

A maximum of 8 alarm modules may be connected to EMCP 3 on one CAN data link.

Other Alarm Modules & Panels

When using alarm modules and panels not supplied by Caterpillar, the following features are recommended.

- Fault light lock-in circuitry - keeps fault light on when intermittent faults occur.
- Lockout of additional alarm lights - prevents subsequent alarm lights from going on after the activated engine shutoff stops the engine. This aids in troubleshooting.
- Alarm silence - allows engine operator to acknowledge the alarm without having to continually listen to the alarm horn. Alarm light is left on.
- If more than one engine is connected to an alarm panel, a fault in a second engine should activate the alarm, even though the alarm horn may have been silenced after a fault on another engine.
- Circuit Test - provides for periodic checking of alarm panel functions

Customer Interface Module (CIM)

The Customer Interface Module (CIM) provides an interface (separate relay contacts) between the GSC for EMCP II and the switchgear. The two major components of the CIM are the relay board and the electronic control. The electronic control connects to the serial data link and decodes the information into discrete outputs. The output drives relays to sound a horn, flash a lamp, or trigger some other action. Information available from the serial data link includes the following.

- High coolant temperature alarm
- High coolant temperature shutdown
- Low coolant temperature alarm
- Low coolant temperature shutdown
- Low oil pressure alarm
- Low oil pressure shutdown
- Overcrank
- Overspeed
- Engine control switch not in auto
- Diagnostic failure

The CIM is normally shipped loose for installation in a convenient location, such as the switch gear. The CIM must be located within 305 m (1000 ft) of the GSC.

Customer Supplied Shutoffs

Customer supplied shutoffs must meet all Caterpillar and other local requirements. Caterpillar requires at a minimum a duplication of the safeties and shutdowns that would have been provided by Caterpillar for the particular engine. These safeties and their limiting values are shown for each engine in the product description section of the price list and in the Operation and

Maintenance Manuals for each engine model. For a typical 3500 series engine, the Caterpillar system provides the following features.

- Emergency stop button
- Energized to shutoff solenoid valves
- Power, warning, and shutdown lights
- Start, stop, run switch

Engine Communication Methods

Customer Communication Module (CCM)

The Customer Communication Module (CCM) provides a communication link between the electronic control system of an engine and a host device. An example of this module is shown in **Figure 7**. The communication link is established with the CAT Data Link and the industry standard RS-232C port. The host device can be one of the following items.

- Personal Computer (PC)
- Programmable Logic Controller (PLC)
- Any other device with an RS-232C port

The host device can be connected directly to the CCM or can be used with a modem.

If the host device is a PC, software that is compatible with the CCM is available from Caterpillar.

The host device will usually be a PLC, and the CCM can be used with a customized PLC software. Refer to the Operation and Maintenance Manuals for each engine model for further information on this subject.

Customer Communication Module

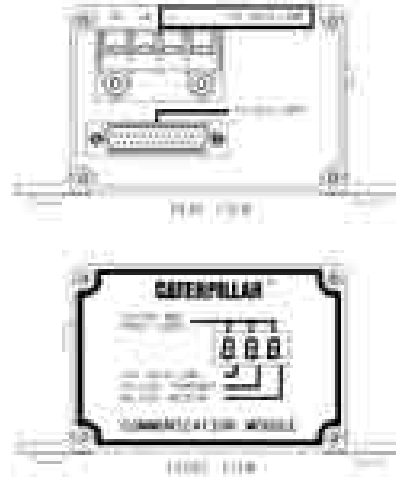

Figure 7

Programmable Relay Control Module (PRCM)

The Programmable Relay Control Module (PRCM) provides the control of seven relays, six alarms and two LED displays. In addition, the PRCM can be programmed to control up to two Relay Driver Modules (RDM), each of which provide an additional nine relay outputs, for a total of 25 relays. The PRCM receives information via the CAT data link from the Engine Control Module (ECM), utilizing information from the eight switched inputs on the PRCM to control the output. Control of each relay is programmable through the keypad and displayed on the PRCM.

Relay Driver Module (RDM)

The Relay Driver Module (RDM) expands the number of available relay outputs on the PRCM, each RDM providing nine additional relay

outputs. The outputs of the RDM are individually controlled via a serial data link from the PRCM, and may drive the optional relay board, or can be directly connected to horns, lamps or other devices. The relay board contains nine relays, each with a set of normally open (NO) and normally closed (NC) contacts. The maximum length of wire between the RDM and PRCM is 305 m (1000 feet).

Caterpillar PL1000 Series Communication Modules

The Caterpillar PL1000 Communication Modules are ECM's that provide the customer with the processing power, memory, numerous communications interfaces and software to integrate Caterpillar engines into many mobile and industrial applications. The modules' flexible communications architecture can potentially replace many of today's purpose built applications and provide almost limitless possibilities for future applications. An example of the PL 1000 Series communication module is shown in **Figure 8**.

A software tool, Caterpillar Communications Toolkit, media number EERP1000 is available to facilitate installation, programming and troubleshooting to PL1000 modules.

PL1000 Communications Module



Figure 8

PL1000T Communication Module

This module will specifically replace the Caterpillar Customer Communications Module (CCM), Caterpillar Engine Vision Interface Module (EVIM) and Caterpillar GPS Interface Module (GPSIM). The following list describes the module's features and benefits.

- EVIM Replacement - enables the Engine Vision Display System to access Caterpillar proprietary engine parameter data.
- GPSIM Replacement - relays GPS location and heading information using the NMEA-183 protocol from a GPS receiver to a monitoring system or display through a CDL or J1939 network. The GPSIM replacement application provides translation of water temperature and depth information gathered using sonar technology.
- CDL Boost - enables a customer to extend lengths

- of CDL harnessing to a maximum distance of 305 m (1000 feet) while maintaining data integrity.
- Embedded Communications Adapter - provides an onboard CDL and J1939 connection interface between the PL1000T ECM and a laptop or PC for the Caterpillar Electronic Service Tool. This connection requires no other equipment than a serial connection from the harness or an extension cable.
 - J1939 to J1939 Bridge - enables extended lengths of J1939 harnessing to a maximum of 80 m (260 feet), doubling the J1939 standard harness specifications.
 - J1939 to RS-485 to CAN Extension Bridge - enables long distance relay of J1939 information via an RS-485 twisted pair for a maximum length of 305 m (1000 feet). Note: This distance specification is directly affected by the customer selected communications rates.
 - CDL Tunneling through J1939 - enables CDL messages to be received through the physical CAN/J1939 data link. This is only used with Caterpillar engine configurations that require a secondary CAT data link, but must utilize a physical CAN port.
- PL1000E Communication Module**
- This module will specifically provide a user configurable parameter translation from Caterpillar proprietary Cat Data Link to a Modbus interface, or from an industry standard J1939 data link (including Caterpillar proprietary messaging) to a Modbus interface. The following describes the module's features and benefits:
- Cat Data Link to Modbus Translation - provides translation of parameter data from the proprietary CDL protocol to the industry standard Modbus interface. This capability replaces the use of multiple conversion tools with a direct conversion from CDL data to the Modbus protocol.
 - J1939 to Modbus Translation - provides translation of parameter data from the proprietary CDL protocol to an industry standard Modbus-enabled interface. This capability replaces the use of multiple conversion tools with a direct conversion from J1939 data to the Modbus protocol.
 - User Configurable Parameter Translation - provides the user or system integrator the opportunity to customize the data translated by the PL1000E Communication Module by selecting CAT Electronic Technician supported parameters to translate as well as specifying

- the source and destination of the translated data.
- Web Server - The PL1000 E Communication Module provides the capability to view web pages stored on the ECM. The Status and Configuration Pages are part of the software initially configured on the PL1000E Communication Module. These pages are accessible to the user via most standard web browsers and provide the same PL1000E information as the Caterpillar Electronic Technician Status and Configuration screens.
 - CDL Boost - enables a customer to extend lengths of CDL harnessing to a maximum distance of 305 m (1000 feet) while maintaining data integrity.
 - Embedded Communications Adapter - provides an onboard CDL and J1939 connection interface between the PL1000E ECM and a laptop or PC for the Caterpillar Electronic Service Tool. This connection requires no other equipment than a serial connection from the harness or an extension cable.

Wiring Methods and Considerations

Wire Size and Type

It is imperative to size the wire according to the maximum amperage the wire will carry. Improper sizing can result in excessive voltage drop of the signal or supply and heat dissipation in the wire. Wire size needs to be considered from battery or power supply to low voltage signal wiring. Refer to the NFPA, National Electric Code or similar for wire sizing tables.

Generally, use shielded wire for magnetic pickups as well as wiring for the electronic governor actuator. The shield should be grounded on one end only to prevent current flow from creating a potential noise source in the shield. Shield breakouts should not exceed 51 mm (2 in) in length.

Factory supplied RTD's are commonly 100 Ohm Platinum or 10 Ohm Copper. Factory supplied thermocouples are commonly type K Chromel-Alumel or type J Iron-Constantan. Care must be taken when attaching additional wiring at the job site. The wrong material, incorrect fastening or different lengths can result in erroneous temperature readings.

Wire Insulation

Consideration of wire insulation will allow proper usage to protect the current conductors from environmental conditions and abrasion. It will also contribute to the ampacity of the wire. Ampacity is a measured amount of amperage a

conductor can carry without exceeding its temperature limits.

Support & Protection of Harnesses

Harnesses should be installed and routed to prevent accidental contact by personnel or components that may wear into the conductors. Unavoidable contact with vibrating components requires protection to prevent wear into the harness.

Depending on method of harnessing, either bundled wires in a flexible sleeve or in rigid conduit, the harnesses should be supported as needed to prevent sagging or strain on the conductors. Provide support between 150 to 300 mm (6 to 12 in) on either side of the connectors. This support distance prevents vibrations from being induced into the connector and prevents undue strain of the connector's weight on the conductors.

Connectors

It is imperative that connectors be applied that are acceptable to the specific application. Sealing and vibration capabilities need to be considered for reliability. A minimum sealing capability of 35 kPa (5 psi) and vibration capability of 30 G's rms (100 to 2000 Hz) should be considered in engine applications.

Moisture ingress, of the connector, will allow the formation of corrosion and create a conductive path between conductors. Excessive vibration will allow the wearing

away of the metal at the contact points of the connector, also called pin fretting. Corrosion and pin fretting may cause intermittent or complete failure of the connector.

Routing Considerations

Wiring for DC circuits, magnetic pickups, thermocouples and RTD's can be routed in common conduits. However, they must not be in the same conduit with AC circuits. In addition, AC circuits greater than 600 volts should be separated from AC circuits less than 600 volts.

Route harnesses and wires away from hot exhaust manifolds and turbochargers, unless special insulation is provided. Route so wiring is protected from abrasive wear (such as grommets). Avoid sharp harness radii to reduce unnecessary wire connection strain. Route harnesses such that someone standing on equipment does not strain wiring.

Metal conduit will help reduce electrical noise, therefore, it's preferred to plastic conduit.

Avoid coiling extra wire length as it can create an electromagnetic compatibility (EMC) issue. Extra wire length should be cut off.

Ground loops should be avoided. Ground points should not be painted. Electrical codes and service publications or instructions may provide additional requirements.

IEEE Standard 142 (Recommended Practice for Grounding of Industrial and Commercial Power Systems), IEEE Standard 1100 (Recommended Practice for Powering and Grounding Sensitive Electronic Equipment) may also provide additional assistance.

To avoid potential noise, signal wiring should not exceed 30 m (98 ft) in length.

Installations with severe electromagnetic interference (EMI) may require shielded wire run in conduit, double shielded wire, or other precautions.

Reference Material

Media List

The following information is provided as an additional reference to subjects discussed in this manual.

EERP1000: Caterpillar Communications Toolkit

LEBE5255: EMCP 3 Application & Installation Guide

REHS1187: Electronic Installation Guide for 3126B, C7, C9, C12, C15, C18, and C32 Marine Engines

